

5

4

3

2

1

4X #8-32UNC-2B
EQUALLY SPACED
NOTE 1

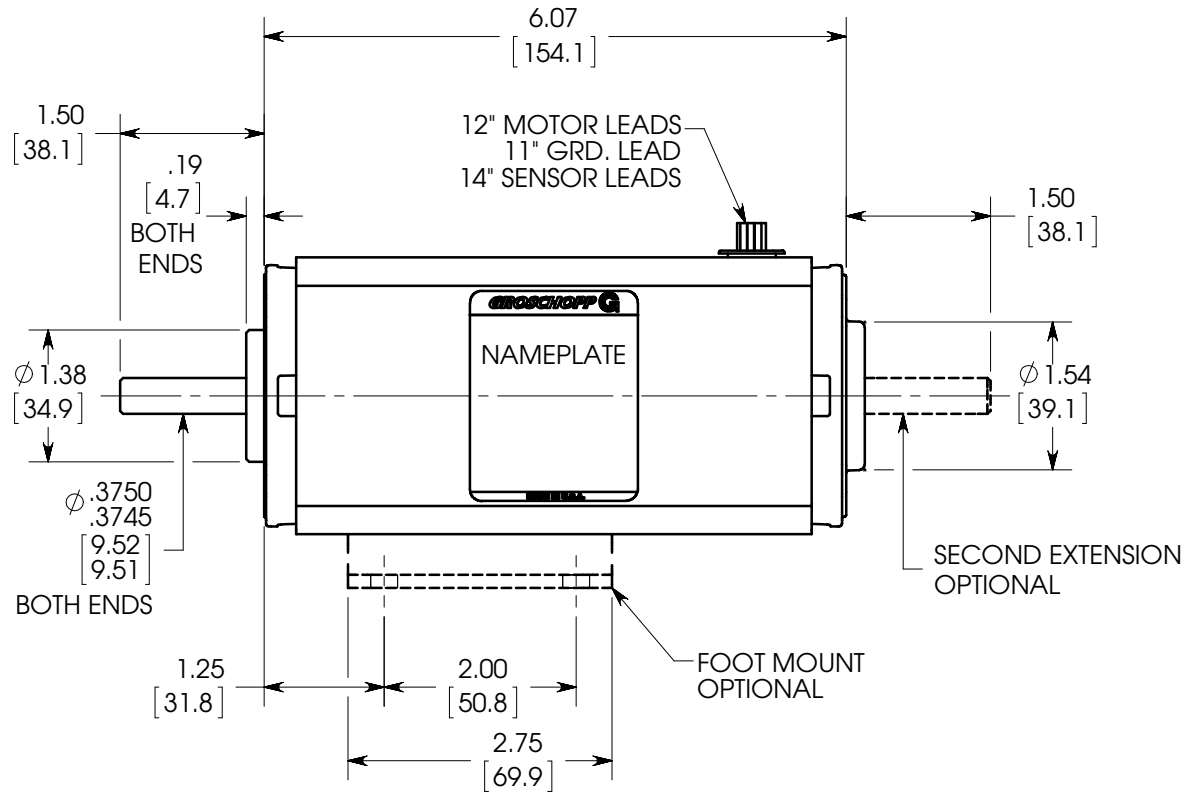
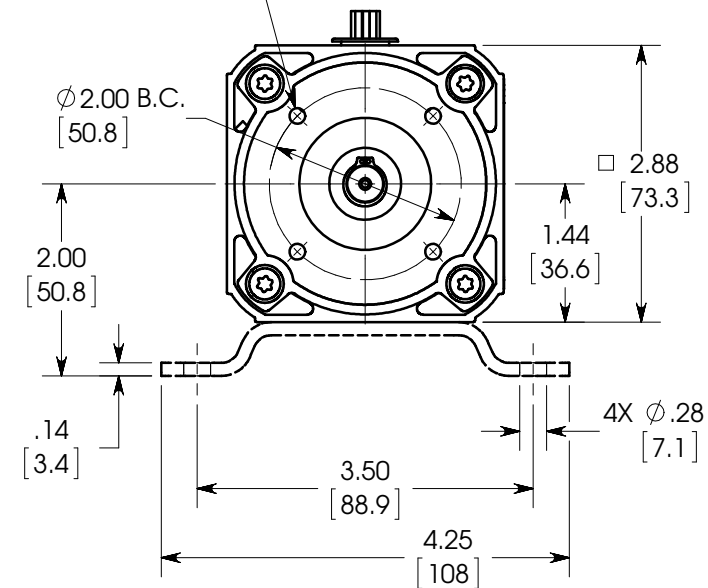

NOTES:

1. BOLT DEPTH NOT TO EXCEED 7/16" FROM END BELL FACE.
2. ALL DIMENSIONS ARE NOMINAL.
3. (mm) = MILLIMETERS.

REVISION	1
CHECKED	BW
DATE	1-15-13
MODEL	BL6560



TITLE:
BL6560
CATALOG STANDARD



THIRD ANGLE

SCALE: 1:2 DO NOT SCALE DRAWING SHEET 1 OF 1

5

4

3

2

1