

5

4

3

2

1

D

D

C

C

B

B

A

A

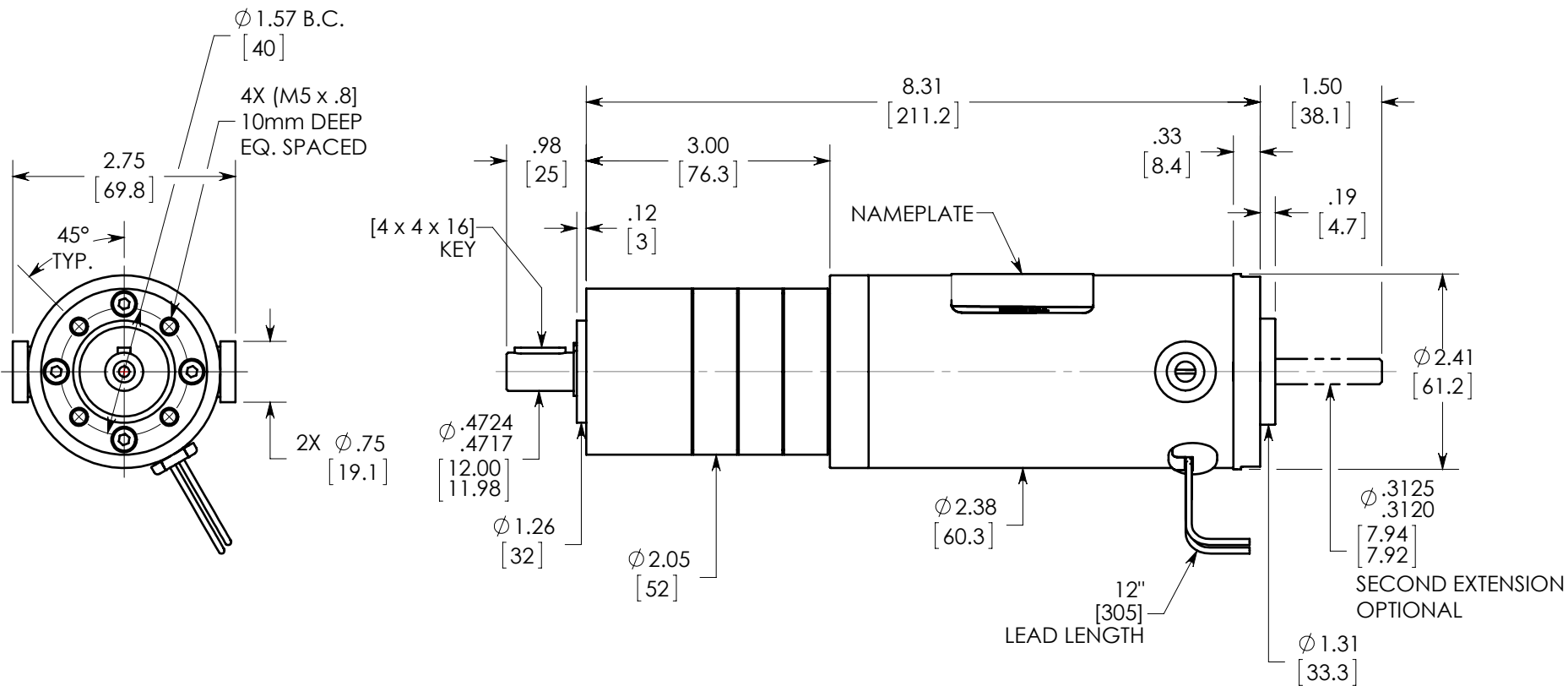

NOTES:

1. ALL DIMENSIONS ARE NOMINAL.
2. [mm] = MILLIMETERS.

REVISION	1
CHECKED	JO
DATE	4-30-13
MODEL	PM6015-PL52i



TITLE: PM6015-PL52_i
59:1 - 308:1 RATIO
CATALOG STANDARD

SCALE: 1:2 DO NOT SCALE DRAWING SHEET 1 OF 1

5

4

3

2

1